

# SUPPLY ARRANGEMENT FOR WORK SPACES

## Category 3: Metal Filing & Storage Cabinets

**NMSA # E60PQ-140003/043/PQ**

Product Guide

Effective January 18, 2016

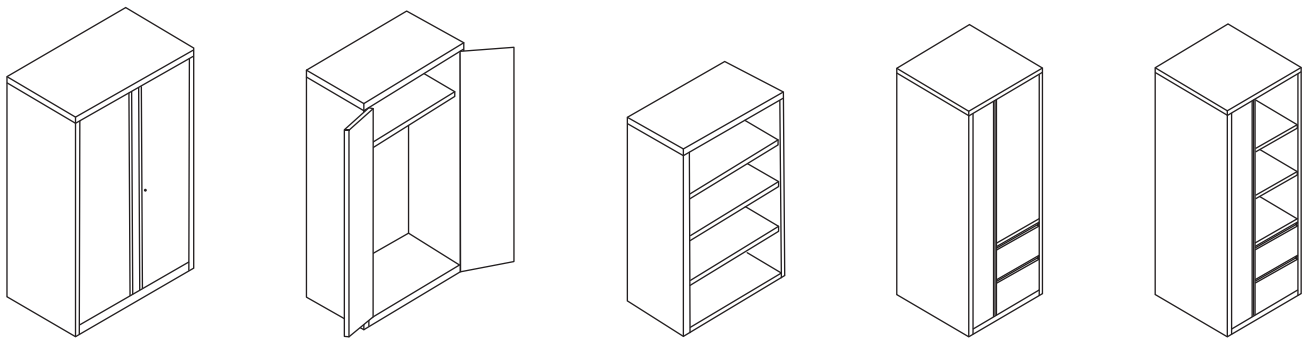
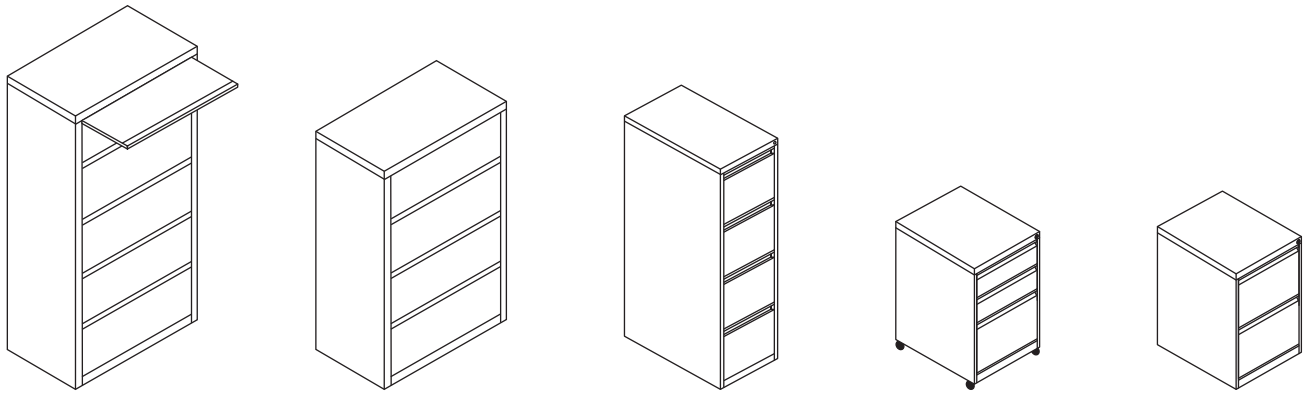

**PERFIX INC.**

450-435-0540  
sales@perfix.ca  
www.perfix.ca

**SUPPLY ARRANGEMENT FOR WORKSPACES**  
**NMSA # E60PQ-140003/043/PQ**  
Effective January 18, 2016

| <b>SERIES</b>                                  | <b>PAGE</b> |
|--|-------------|
| STORAGE CABINETS / WARDROBE CABINETS . . . . . | 3           |
| OPEN WARDROBE CABINETS . . . . .               | 4           |
| OPEN BOOKCASES . . . . .                       | 5           |
| LOCKING LATERAL FILING CABINETS . . . . .      | 6           |
| LOCKING VERTICAL FILING CABINETS. . . . .      | 7           |
| PERSONAL STORAGE TOWERS . . . . .              | 9           |
| PEDESTALS (ON CASTERS). . . . .                | 10          |
| PEDESTALS (ON GLIDES) . . . . .                | 11          |

**DELIVERIES**

2 - 4 weeks.

**COLOR FINISHES**

12 standard colors, please refer to color chart.

**TRANSPORTATION**

Extra, F.O.B, our factory Boisbriand, Qc.

Please contact our Customer Service Department for Freight quote.

**INSTALLATION**

Extra, Please contact our Customer Service Department for Installation quote.

**PRICING**

Price upon request.



## STORAGE CABINETS

### HINGED DOORS

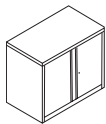
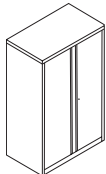
| MODEL   | DESCRIPTION                              | GOVERNMENT<br>GoCUIC       | WIDTH<br>" (mm) | DEPTH<br>" (mm) | HEIGHT<br>" (mm)                       | PERFIX<br>CODE     | CEILING<br>PRICE \$ |
|---|--|----------------------------|-----------------|-----------------|--|--------------------|---------------------|
|    | Two-door<br>storage cabinet<br>1 shelf   | <b>SCSC2DSCxxx18362433</b> | 36 (914)        | 18 (457)        | 27 <sup>7</sup> / <sub>8</sub> (708)   | <b>20-1-361824</b> | -                   |
|   |  | <b>SCSC2DSCxxx20362433</b> | 36 (914)        | 20 (508)        | 27 <sup>7</sup> / <sub>8</sub> (708)   | <b>20-1-362024</b> | -                   |
|   |  | <b>SCSC2DSCxxx24362433</b> | 36 (914)        | 24 (610)        | 27 <sup>7</sup> / <sub>8</sub> (708)   | <b>20-1-362424</b> | -                   |
|   |  | <b>SCSC2DSCxxx18422433</b> | 42 (1067)       | 18 (457)        | 27 <sup>7</sup> / <sub>8</sub> (708)   | <b>20-1-421824</b> | -                   |
|   |  | <b>SCSC2DSCxxx20422433</b> | 42 (1067)       | 20 (508)        | 27 <sup>7</sup> / <sub>8</sub> (708)   | <b>20-1-422024</b> | -                   |
|   |  | <b>SCSC2DSCxxx24422433</b> | 42 (1067)       | 24 (610)        | 27 <sup>7</sup> / <sub>8</sub> (708)   | <b>20-1-422424</b> | -                   |
|    | Two-door<br>storage cabinet<br>2 shelves | <b>SCSC2DSCxxx18363443</b> | 36 (914)        | 18 (457)        | 40 <sup>1</sup> / <sub>16</sub> (1018) | <b>20-2-361836</b> | -                   |
|   |  | <b>SCSC2DSCxxx20363443</b> | 36 (914)        | 20 (508)        | 40 <sup>1</sup> / <sub>16</sub> (1018) | <b>20-2-362036</b> | -                   |
|   |  | <b>SCSC2DSCxxx24363443</b> | 36 (914)        | 24 (610)        | 40 <sup>1</sup> / <sub>16</sub> (1018) | <b>20-2-362436</b> | -                   |
|   |  | <b>SCSC2DSCxxx18423443</b> | 42 (1067)       | 18 (457)        | 40 <sup>1</sup> / <sub>16</sub> (1018) | <b>20-2-421836</b> | -                   |
|   |  | <b>SCSC2DSCxxx20423443</b> | 42 (1067)       | 20 (508)        | 40 <sup>1</sup> / <sub>16</sub> (1018) | <b>20-2-422036</b> | -                   |
|   |  | <b>SCSC2DSCxxx24423443</b> | 42 (1067)       | 24 (610)        | 40 <sup>1</sup> / <sub>16</sub> (1018) | <b>20-2-422436</b> | -                   |
|  | Two-door<br>storage cabinet<br>3 shelves | <b>SCSC2DSCxxx18364454</b> | 36 (914)        | 18 (457)        | 53 <sup>3</sup> / <sub>8</sub> (1356)  | <b>20-3-361848</b> | -                   |
|   |  | <b>SCSC2DSCxxx20364454</b> | 36 (914)        | 20 (508)        | 53 <sup>3</sup> / <sub>8</sub> (1356)  | <b>20-3-362048</b> | -                   |
|   |  | <b>SCSC2DSCxxx24364454</b> | 36 (914)        | 24 (610)        | 53 <sup>3</sup> / <sub>8</sub> (1356)  | <b>20-3-362448</b> | -                   |
|   |  | <b>SCSC2DSCxxx18424454</b> | 42 (1067)       | 18 (457)        | 53 <sup>3</sup> / <sub>8</sub> (1356)  | <b>20-3-421848</b> | -                   |
|   |  | <b>SCSC2DSCxxx20424454</b> | 42 (1067)       | 20 (508)        | 53 <sup>3</sup> / <sub>8</sub> (1356)  | <b>20-3-422048</b> | -                   |
|   |  | <b>SCSC2DSCxxx24424454</b> | 42 (1067)       | 24 (610)        | 53 <sup>3</sup> / <sub>8</sub> (1356)  | <b>20-3-422448</b> | -                   |

## WARDROBE CABINETS

### HINGED DOORS

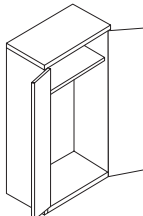
|   |   |                            |           |          |                                       |                        |   |
|---|---|----------------------------|-----------|----------|---------------------------------------|------------------------|---|
|  | Two-door<br>wardrobe cabinet<br>1 shelf<br>1 coat rod | <b>WARD2DSCxxx20364454</b> | 36 (914)  | 20 (508) | 53 <sup>3</sup> / <sub>8</sub> (1356) | <b>20-W-809-362048</b> | - |
|   |   | <b>WARD2DSCxxx24364454</b> | 36 (914)  | 24 (610) | 53 <sup>3</sup> / <sub>8</sub> (1356) | <b>20-W-809-362448</b> | - |
|   |   | <b>WARD2DSCxxx20424454</b> | 42 (1067) | 20 (508) | 53 <sup>3</sup> / <sub>8</sub> (1356) | <b>20-W-809-422048</b> | - |
|   |   | <b>WARD2DSCxxx24424454</b> | 42 (1067) | 24 (610) | 53 <sup>3</sup> / <sub>8</sub> (1356) | <b>20-W-809-422448</b> | - |

## OPEN WARDROBE CABINETS

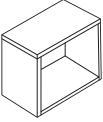
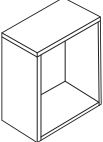
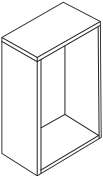
| MODEL  | DESCRIPTION                         | GOVERNMENT<br>GoCUIC       | WIDTH<br>" (mm) | DEPTH<br>" (mm) | HEIGHT<br>" (mm)                       | PERFIX<br>CODE       | CEILING<br>PRICE \$ |
|--|-------------------------------------|----------------------------|-----------------|-----------------|--|----------------------|---------------------|
|    | Open wardrobe cabinet<br>1 coat rod | <b>WARDOPSCxxx18302433</b> | 30 (762)        | 18 (457)        | 27 <sup>7</sup> / <sub>8</sub> (708)   | <b>20-809-301824</b> | —                   |
|  |                                     | <b>WARDOPSCxxx18362433</b> | 36 (914)        | 18 (457)        | 27 <sup>7</sup> / <sub>8</sub> (708)   | <b>20-809-361824</b> | —                   |
|  |                                     | <b>WARDOPSCxxx18422433</b> | 42 (1067)       | 18 (457)        | 27 <sup>7</sup> / <sub>8</sub> (708)   | <b>20-809-421824</b> | —                   |
|  |                                     | <b>WARDOPSCxxx18482433</b> | 48 (1219)       | 18 (457)        | 27 <sup>7</sup> / <sub>8</sub> (708)   | <b>20-809-481824</b> | —                   |
|  |                                     | <b>WARDOPSCxxx20302433</b> | 30 (762)        | 20 (508)        | 27 <sup>7</sup> / <sub>8</sub> (708)   | <b>20-809-302024</b> | —                   |
|  |                                     | <b>WARDOPSCxxx20362433</b> | 36 (914)        | 20 (508)        | 27 <sup>7</sup> / <sub>8</sub> (708)   | <b>20-809-362024</b> | —                   |
|  |                                     | <b>WARDOPSCxxx20422433</b> | 42 (1067)       | 20 (508)        | 27 <sup>7</sup> / <sub>8</sub> (708)   | <b>20-809-422024</b> | —                   |
|  |                                     | <b>WARDOPSCxxx20482433</b> | 48 (1219)       | 20 (508)        | 27 <sup>7</sup> / <sub>8</sub> (708)   | <b>20-809-482024</b> | —                   |
|    | Open wardrobe cabinet<br>1 coat rod | <b>WARDOPSCxxx18303443</b> | 30 (762)        | 18 (457)        | 40 <sup>1</sup> / <sub>16</sub> (1018) | <b>20-809-301836</b> | —                   |
|  |                                     | <b>WARDOPSCxxx18363443</b> | 36 (914)        | 18 (457)        | 40 <sup>1</sup> / <sub>16</sub> (1018) | <b>20-809-361836</b> | —                   |
|  |                                     | <b>WARDOPSCxxx18423443</b> | 42 (1067)       | 18 (457)        | 40 <sup>1</sup> / <sub>16</sub> (1018) | <b>20-809-421836</b> | —                   |
|  |                                     | <b>WARDOPSCxxx18483443</b> | 48 (1219)       | 18 (457)        | 40 <sup>1</sup> / <sub>16</sub> (1018) | <b>20-809-481836</b> | —                   |
|  |                                     | <b>WARDOPSCxxx20303443</b> | 30 (762)        | 20 (508)        | 40 <sup>1</sup> / <sub>16</sub> (1018) | <b>20-809-302036</b> | —                   |
|  |                                     | <b>WARDOPSCxxx20363443</b> | 36 (914)        | 20 (508)        | 40 <sup>1</sup> / <sub>16</sub> (1018) | <b>20-809-362036</b> | —                   |
|  |                                     | <b>WARDOPSCxxx20423443</b> | 42 (1067)       | 20 (508)        | 40 <sup>1</sup> / <sub>16</sub> (1018) | <b>20-809-422036</b> | —                   |
|  |                                     | <b>WARDOPSCxxx20483443</b> | 48 (1219)       | 20 (508)        | 40 <sup>1</sup> / <sub>16</sub> (1018) | <b>20-809-482036</b> | —                   |
|  | Open wardrobe cabinet<br>1 coat rod | <b>WARDOPSCxxx18304454</b> | 30 (762)        | 18 (457)        | 53 <sup>3</sup> / <sub>8</sub> (1356)  | <b>20-809-301848</b> | —                   |
|  |                                     | <b>WARDOPSCxxx18364454</b> | 36 (914)        | 18 (457)        | 53 <sup>3</sup> / <sub>8</sub> (1356)  | <b>20-809-361848</b> | —                   |
|  |                                     | <b>WARDOPSCxxx18424454</b> | 42 (1067)       | 18 (457)        | 53 <sup>3</sup> / <sub>8</sub> (1356)  | <b>20-809-421848</b> | —                   |
|  |                                     | <b>WARDOPSCxxx18484454</b> | 48 (1219)       | 18 (457)        | 53 <sup>3</sup> / <sub>8</sub> (1356)  | <b>20-809-481848</b> | —                   |
|  |                                     | <b>WARDOPSCxxx20304454</b> | 30 (762)        | 20 (508)        | 53 <sup>3</sup> / <sub>8</sub> (1356)  | <b>20-809-302048</b> | —                   |
|  |                                     | <b>WARDOPSCxxx20364454</b> | 36 (914)        | 20 (508)        | 53 <sup>3</sup> / <sub>8</sub> (1356)  | <b>20-809-362048</b> | —                   |
|  |                                     | <b>WARDOPSCxxx20424454</b> | 42 (1067)       | 20 (508)        | 53 <sup>3</sup> / <sub>8</sub> (1356)  | <b>20-809-422048</b> | —                   |
|  |                                     | <b>WARDOPSCxxx20484454</b> | 48 (1219)       | 20 (508)        | 53 <sup>3</sup> / <sub>8</sub> (1356)  | <b>20-809-482048</b> | —                   |

## OPEN BOOKCASES

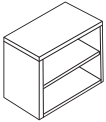
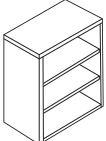
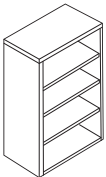
| MODEL   | DESCRIPTION                | GOVERNMENT<br>GoCUIC       | WIDTH<br>" (mm) | DEPTH<br>" (mm) | HEIGHT<br>" (mm)                       | PERFIX<br>CODE     | CEILING<br>PRICE \$ |
|---|----------------------------|----------------------------|-----------------|-----------------|--|--------------------|---------------------|
|    | Open bookcase<br>1 shelf   | <b>SCSCOPSCxxx18302433</b> | 30 (762)        | 18 (457)        | 27 <sup>7</sup> / <sub>8</sub> (708)   | <b>12-1-301824</b> | -                   |
|   |                            | <b>SCSCOPSCxxx18362433</b> | 36 (914)        | 18 (457)        | 27 <sup>7</sup> / <sub>8</sub> (708)   | <b>12-1-361824</b> | -                   |
|   |                            | <b>SCSCOPSCxxx18422433</b> | 42 (1067)       | 18 (457)        | 27 <sup>7</sup> / <sub>8</sub> (708)   | <b>12-1-421824</b> | -                   |
|   |                            | <b>SCSCOPSCxxx18482433</b> | 48 (1219)       | 18 (457)        | 27 <sup>7</sup> / <sub>8</sub> (708)   | <b>12-1-481824</b> | -                   |
|   |                            | <b>SCSCOPSCxxx20302433</b> | 30 (762)        | 20 (508)        | 27 <sup>7</sup> / <sub>8</sub> (708)   | <b>12-1-302024</b> | -                   |
|   |                            | <b>SCSCOPSCxxx20362433</b> | 36 (914)        | 20 (508)        | 27 <sup>7</sup> / <sub>8</sub> (708)   | <b>12-1-362024</b> | -                   |
|   |                            | <b>SCSCOPSCxxx20422433</b> | 42 (1067)       | 20 (508)        | 27 <sup>7</sup> / <sub>8</sub> (708)   | <b>12-1-422024</b> | -                   |
|   |                            | <b>SCSCOPSCxxx20482433</b> | 48 (1219)       | 20 (508)        | 27 <sup>7</sup> / <sub>8</sub> (708)   | <b>12-1-482024</b> | -                   |
|    | Open bookcase<br>2 shelves | <b>SCSCOPSCxxx18303443</b> | 30 (762)        | 18 (457)        | 40 <sup>1</sup> / <sub>16</sub> (1018) | <b>12-2-301836</b> | -                   |
|   |                            | <b>SCSCOPSCxxx18363443</b> | 36 (914)        | 18 (457)        | 40 <sup>1</sup> / <sub>16</sub> (1018) | <b>12-2-361836</b> | -                   |
|   |                            | <b>SCSCOPSCxxx18423443</b> | 42 (1067)       | 18 (457)        | 40 <sup>1</sup> / <sub>16</sub> (1018) | <b>12-2-421836</b> | -                   |
|   |                            | <b>SCSCOPSCxxx18483443</b> | 48 (1219)       | 18 (457)        | 40 <sup>1</sup> / <sub>16</sub> (1018) | <b>12-2-481836</b> | -                   |
|   |                            | <b>SCSCOPSCxxx20303443</b> | 30 (762)        | 20 (508)        | 40 <sup>1</sup> / <sub>16</sub> (1018) | <b>12-2-302036</b> | -                   |
|   |                            | <b>SCSCOPSCxxx20363443</b> | 36 (914)        | 20 (508)        | 40 <sup>1</sup> / <sub>16</sub> (1018) | <b>12-2-362036</b> | -                   |
|   |                            | <b>SCSCOPSCxxx20423443</b> | 42 (1067)       | 20 (508)        | 40 <sup>1</sup> / <sub>16</sub> (1018) | <b>12-2-422036</b> | -                   |
|   |                            | <b>SCSCOPSCxxx20483443</b> | 48 (1219)       | 20 (508)        | 40 <sup>1</sup> / <sub>16</sub> (1018) | <b>12-2-482036</b> | -                   |
|  | Open bookcase<br>3 shelves | <b>SCSCOPSCxxx18304454</b> | 30 (762)        | 18 (457)        | 53 <sup>3</sup> / <sub>8</sub> (1356)  | <b>12-3-301848</b> | -                   |
|   |                            | <b>SCSCOPSCxxx18364454</b> | 36 (914)        | 18 (457)        | 53 <sup>3</sup> / <sub>8</sub> (1356)  | <b>12-3-361848</b> | -                   |
|   |                            | <b>SCSCOPSCxxx18424454</b> | 42 (1067)       | 18 (457)        | 53 <sup>3</sup> / <sub>8</sub> (1356)  | <b>12-3-421848</b> | -                   |
|   |                            | <b>SCSCOPSCxxx18484454</b> | 48 (1219)       | 18 (457)        | 53 <sup>3</sup> / <sub>8</sub> (1356)  | <b>12-3-481848</b> | -                   |
|   |                            | <b>SCSCOPSCxxx20304454</b> | 30 (762)        | 20 (508)        | 53 <sup>3</sup> / <sub>8</sub> (1356)  | <b>12-3-302048</b> | -                   |
|   |                            | <b>SCSCOPSCxxx20364454</b> | 36 (914)        | 20 (508)        | 53 <sup>3</sup> / <sub>8</sub> (1356)  | <b>12-3-362048</b> | -                   |
|   |                            | <b>SCSCOPSCxxx20424454</b> | 42 (1067)       | 20 (508)        | 53 <sup>3</sup> / <sub>8</sub> (1356)  | <b>12-3-422048</b> | -                   |
|   |                            | <b>SCSCOPSCxxx20484454</b> | 48 (1219)       | 20 (508)        | 53 <sup>3</sup> / <sub>8</sub> (1356)  | <b>12-3-482048</b> | -                   |

## LOCKING LATERAL FILING CABINETS

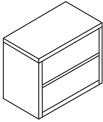
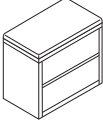
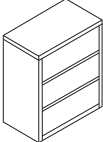
| MODEL  | DESCRIPTION  | GOVERNMENT<br>GoCUIC        | WIDTH<br>" (mm) | DEPTH<br>" (mm) | HEIGHT<br>" (mm)                       | PERFIX<br>CODE         | CEILING<br>PRICE \$ |
|--|--|-----------------------------|-----------------|-----------------|--|------------------------|---------------------|
|    | Lateral file<br>Two (2) fixed<br>front drawers                     | <b>LLFC2Dxxxxx1830xxxx</b>  | 30 (762)        | 18 (457)        | 27 <sup>7</sup> / <sub>8</sub> (708)   | <b>2021-33-30</b>      | —                   |
|  |  | <b>LLFC2Dxxxxx2030xxxx</b>  | 30 (762)        | 20 (508)        | 27 <sup>7</sup> / <sub>8</sub> (708)   | <b>2021-600-302024</b> | —                   |
|  |  | <b>LLFC2DFDxxx1836xxxx</b>  | 36 (914)        | 18 (457)        | 27 <sup>7</sup> / <sub>8</sub> (708)   | <b>2021-33-36</b>      | —                   |
|  |  | <b>LLFC2DFDxxx2036xxxx</b>  | 36 (914)        | 20 (508)        | 27 <sup>7</sup> / <sub>8</sub> (708)   | <b>2021-600-362024</b> | —                   |
|  |  | <b>LLFC2DFDxxx1842xxxx</b>  | 42 (1067)       | 18 (457)        | 27 <sup>7</sup> / <sub>8</sub> (708)   | <b>2021-33-42</b>      | —                   |
|  |  | <b>LLFC2DFDxxx2042xxxx</b>  | 42 (1067)       | 20 (508)        | 27 <sup>7</sup> / <sub>8</sub> (708)   | <b>2021-600-422024</b> | —                   |
|    | Lateral file<br>Two (2) fixed<br>front drawers<br>with cushion top | <b>LLFC2DCTxxx1830xxxx</b>  | 30 (762)        | 18 (457)        | 27 <sup>7</sup> / <sub>8</sub> (708)   | <b>2021-609-301824</b> | —                   |
|  |  | <b>LLFC2DCTxxx2030xxxx</b>  | 30 (762)        | 20 (508)        | 27 <sup>7</sup> / <sub>8</sub> (708)   | <b>2021-609-302024</b> | —                   |
|  |  | <b>LLFC2DFCTxx1836xxxx</b>  | 36 (914)        | 18 (457)        | 27 <sup>7</sup> / <sub>8</sub> (708)   | <b>2021-609-361824</b> | —                   |
|  |  | <b>LLFC2DFCTxxx2036xxxx</b> | 36 (914)        | 20 (508)        | 27 <sup>7</sup> / <sub>8</sub> (708)   | <b>2021-609-362024</b> | —                   |
|  |  | <b>LLFC2DFCTxxx1842xxxx</b> | 42 (1067)       | 18 (457)        | 27 <sup>7</sup> / <sub>8</sub> (708)   | <b>2021-609-421824</b> | —                   |
|  |  | <b>LLFC2DFCTxxx2042xxxx</b> | 42 (1067)       | 20 (508)        | 27 <sup>7</sup> / <sub>8</sub> (708)   | <b>2021-609-422024</b> | —                   |
|  | Lateral file<br>Three (3) fixed<br>front drawers                   | <b>LLFC3Dxxxxx1830xxxx</b>  | 30 (762)        | 18 (457)        | 40 <sup>1</sup> / <sub>16</sub> (1018) | <b>2031-333-30</b>     | —                   |
|  |  | <b>LLFC3Dxxxxx2030xxxx</b>  | 30 (762)        | 20 (508)        | 40 <sup>1</sup> / <sub>16</sub> (1018) | <b>2031-600-302036</b> | —                   |
|  |  | <b>LLFC3DFDxxx1836xxxx</b>  | 36 (914)        | 18 (457)        | 40 <sup>1</sup> / <sub>16</sub> (1018) | <b>2031-333-36</b>     | —                   |
|  |  | <b>LLFC3DFDxxx2036xxxx</b>  | 36 (914)        | 20 (508)        | 40 <sup>1</sup> / <sub>16</sub> (1018) | <b>2031-600-362036</b> | —                   |
|  |  | <b>LLFC3DFDxxx1842xxxx</b>  | 42 (1067)       | 18 (457)        | 40 <sup>1</sup> / <sub>16</sub> (1018) | <b>2031-333-42</b>     | —                   |
|  |  | <b>LLFC3DFDxxx2042xxxx</b>  | 42 (1067)       | 20 (508)        | 40 <sup>1</sup> / <sub>16</sub> (1018) | <b>2031-600-422036</b> | —                   |

## LOCKING LATERAL FILING CABINETS

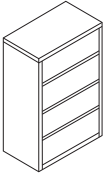
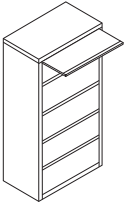
| MODEL   | DESCRIPTION   | GOVERNMENT<br>GoCUIC       | WIDTH<br>" (mm) | DEPTH<br>" (mm) | HEIGHT<br>" (mm)                      | PERFIX<br>CODE         | CEILING<br>PRICE \$ |
|---|---|----------------------------|-----------------|-----------------|---------------------------------------|------------------------|---------------------|
|  | Lateral file<br>Four (4) fixed<br>front drawers   | <b>LLFC4Dxxxxx1830xxxx</b> | 30 (762)        | 18 (457)        | 53 <sup>3</sup> / <sub>8</sub> (1356) | <b>2041-3333-30</b>    | -                   |
|   |   | <b>LLFC4Dxxxxx2030xxxx</b> | 30 (762)        | 20 (508)        | 53 <sup>3</sup> / <sub>8</sub> (1356) | <b>2041-600-302048</b> | -                   |
|   |   | <b>LLFC4DFDxxx1836xxxx</b> | 36 (914)        | 18 (457)        | 53 <sup>3</sup> / <sub>8</sub> (1356) | <b>2041-3333-36</b>    | -                   |
|   |   | <b>LLFC4DFDxxx2036xxxx</b> | 36 (914)        | 20 (508)        | 53 <sup>3</sup> / <sub>8</sub> (1356) | <b>2041-600-362048</b> | -                   |
|   |   | <b>LLFC4DFDxxx1842xxxx</b> | 42 (1067)       | 18 (457)        | 53 <sup>3</sup> / <sub>8</sub> (1356) | <b>2041-3333-42</b>    | -                   |
|   |   | <b>LLFC4DFDxxx2042xxxx</b> | 42 (1067)       | 20 (508)        | 53 <sup>3</sup> / <sub>8</sub> (1356) | <b>2041-600-422048</b> | -                   |
|  | Lateral file<br>Five (5) drawers<br>First top drawer -<br>receding front,<br>other 4 drawers -<br>fixed front | <b>LLFC5DTRFFx1830xxxx</b> | 30 (762)        | 18 (457)        | 65 <sup>1</sup> / <sub>2</sub> (1664) | <b>2051-13333-30</b>   | -                   |
|   |   | <b>LLFC5DTRFFx2030xxxx</b> | 30 (762)        | 20 (508)        | 65 <sup>1</sup> / <sub>2</sub> (1664) | <b>2051-600-302060</b> | -                   |
|   |   | <b>LLFC5DTRFFx1836xxxx</b> | 36 (914)        | 18 (457)        | 65 <sup>1</sup> / <sub>2</sub> (1664) | <b>2051-13333-36</b>   | -                   |
|   |   | <b>LLFC5DTRFFx2036xxxx</b> | 36 (914)        | 20 (508)        | 65 <sup>1</sup> / <sub>2</sub> (1664) | <b>2051-600-362060</b> | -                   |
|   |   | <b>LLFC5DTRFFx1842xxxx</b> | 42 (1067)       | 18 (457)        | 65 <sup>1</sup> / <sub>2</sub> (1664) | <b>2051-13333-42</b>   | -                   |
|   |   | <b>LLFC5DTRFFx2042xxxx</b> | 42 (1067)       | 20 (508)        | 65 <sup>1</sup> / <sub>2</sub> (1664) | <b>2051-600-422060</b> | -                   |

## LOCKING VERTICAL FILING CABINETS

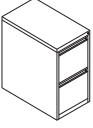
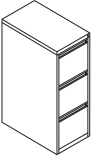
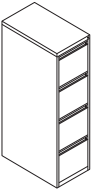
| MODEL  | DESCRIPTION                        | GOVERNMENT<br>GoCUIC       | WIDTH<br>" (mm) | DEPTH<br>" (mm) | HEIGHT<br>" (mm)                       | PERFIX<br>CODE     | CEILING<br>PRICE \$ |
|--|------------------------------------|----------------------------|-----------------|-----------------|--|--------------------|---------------------|
|  | Vertical file<br>Two (2) drawers   | <b>LVFC2Dxxxxx2818xxxx</b> | 18 (457)        | 28 (711)        | 27 <sup>7</sup> / <sub>8</sub> (708)   | <b>99 VF 27-18</b> | —                   |
|  | Vertical file<br>Three (3) drawers | <b>LVFC3Dxxxxx2818xxxx</b> | 18 (457)        | 28 (711)        | 40 <sup>1</sup> / <sub>16</sub> (1018) | <b>99 VF 40-18</b> | —                   |
|  | Vertical file<br>Four (4) drawers  | <b>LVFC4Dxxxxx2818xxxx</b> | 18 (457)        | 28 (711)        | 53 <sup>3</sup> / <sub>8</sub> (1356)  | <b>99 VF 53-18</b> | —                   |



## PERSONAL STORAGE TOWERS

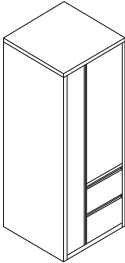
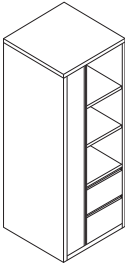

(R = wardrobe at right)

(L= wardrobe at left)

| MODEL   | DESCRIPTION   | GOVERNMENT<br>GoCUIC       | WIDTH<br>" (mm) | DEPTH<br>" (mm) | HEIGHT<br>" (mm)                      | PERFIX<br>CODE       | CEILING<br>PRICE \$ |
|---|---|----------------------------|-----------------|-----------------|---------------------------------------|----------------------|---------------------|
|    | Wardrobe one side<br>2 file drawers<br>at bottom and<br>closed cupboard<br>above, with lock | <b>PSTxW2FCxxx2424Rxxx</b> | 24 (610)        | 24 (610)        | 53 <sup>3</sup> / <sub>8</sub> (1356) | <b>6R-02-242448</b>  | —                   |
|   |   | <b>PSTxW2FCxxx2424Lxxx</b> | 24 (610)        | 24 (610)        | 53 <sup>3</sup> / <sub>8</sub> (1356) | <b>6L-02-242448</b>  | —                   |
|   |   | <b>PSTxW2FCxxx2430Rxxx</b> | 30 (762)        | 24 (610)        | 53 <sup>3</sup> / <sub>8</sub> (1356) | <b>6R-02-302448</b>  | —                   |
|   |   | <b>PSTxW2FCxxx2430Lxxx</b> | 30 (762)        | 24 (610)        | 53 <sup>3</sup> / <sub>8</sub> (1356) | <b>6L-02-302448</b>  | —                   |
|   |   | <b>PSTxW2FCxxx2436Rxxx</b> | 36 (914)        | 24 (610)        | 53 <sup>3</sup> / <sub>8</sub> (1356) | <b>6R-02-362448</b>  | —                   |
|   |   | <b>PSTxW2FCxxx2436Lxxx</b> | 36 (914)        | 24 (610)        | 53 <sup>3</sup> / <sub>8</sub> (1356) | <b>6L-02-362448</b>  | —                   |
|   |   | <b>PSTxW2DLxxx2424Rxxx</b> | 24 (610)        | 24 (610)        | 66 (1676)                             | <b>6R-02-242466</b>  | —                   |
|   |   | <b>PSTxW2DLxxx2424Lxxx</b> | 24 (610)        | 24 (610)        | 66 (1676)                             | <b>6L-02-242466</b>  | —                   |
|   |   | <b>PSTxW2DLxxx2430Rxxx</b> | 30 (762)        | 24 (610)        | 66 (1676)                             | <b>6R-02-302466</b>  | —                   |
|   |   | <b>PSTxW2DLxxx2430Lxxx</b> | 30 (762)        | 24 (610)        | 66 (1676)                             | <b>6L-02-302466</b>  | —                   |
|   |   | <b>PSTxW2DLxxx2436Rxxx</b> | 36 (914)        | 24 (610)        | 66 (1676)                             | <b>6R-02-362466</b>  | —                   |
|   |   | <b>PSTxW2DLxxx2436Lxxx</b> | 36 (914)        | 24 (610)        | 66 (1676)                             | <b>6L-02-362466</b>  | —                   |
|  | Wardrobe one side<br>2 file drawers<br>at bottom and<br>open cupboard<br>above              | <b>PSTxW2FO54x2424Rxxx</b> | 24 (610)        | 24 (610)        | 53 <sup>3</sup> / <sub>8</sub> (1356) | <b>61R-02-242448</b> | —                   |
|   |   | <b>PSTxW2FO54x2424Lxxx</b> | 24 (610)        | 24 (610)        | 53 <sup>3</sup> / <sub>8</sub> (1356) | <b>61L-02-242448</b> | —                   |
|   |   | <b>PSTxW2FO54x2430Rxxx</b> | 30 (762)        | 24 (610)        | 53 <sup>3</sup> / <sub>8</sub> (1356) | <b>61R-02-302448</b> | —                   |
|   |   | <b>PSTxW2FO54x2430Lxxx</b> | 30 (762)        | 24 (610)        | 53 <sup>3</sup> / <sub>8</sub> (1356) | <b>61L-02-302448</b> | —                   |
|   |   | <b>PSTxW2FO54x2436Rxxx</b> | 36 (914)        | 24 (610)        | 53 <sup>3</sup> / <sub>8</sub> (1356) | <b>61R-02-362448</b> | —                   |
|   |   | <b>PSTxW2FO54x2436Lxxx</b> | 36 (914)        | 24 (610)        | 53 <sup>3</sup> / <sub>8</sub> (1356) | <b>61L-02-362448</b> | —                   |
|   |   | <b>PSTxW2FO66x2424Rxxx</b> | 24 (610)        | 24 (610)        | 66 (1676)                             | <b>61R-02-242466</b> | —                   |
|   |   | <b>PSTxW2FO66x2424Lxxx</b> | 24 (610)        | 24 (610)        | 66 (1676)                             | <b>61L-02-242466</b> | —                   |
|   |   | <b>PSTxW2FO66x2430Rxxx</b> | 30 (762)        | 24 (610)        | 66 (1676)                             | <b>61R-02-302466</b> | —                   |
|   |   | <b>PSTxW2FO66x2430Lxxx</b> | 30 (762)        | 24 (610)        | 66 (1676)                             | <b>61L-02-302466</b> | —                   |
|   |   | <b>PSTxW2FO66x2436Rxxx</b> | 36 (914)        | 24 (610)        | 66 (1676)                             | <b>61R-02-362466</b> | —                   |
|   |   | <b>PSTxW2FO66x2436Lxxx</b> | 36 (914)        | 24 (610)        | 66 (1676)                             | <b>61L-02-362466</b> | —                   |

## PEDESTALS

(ON CASTERS)

| MODEL   | DESCRIPTION  | GOVERNMENT<br>GoCUIC         | WIDTH<br>" (mm) | DEPTH<br>" (mm) | HEIGHT<br>" (mm)                     | PERFIX<br>CODE          | CEILING<br>PRICE \$ |
|---|--|------------------------------|-----------------|-----------------|--------------------------------------|-------------------------|---------------------|
|   | Mobile pedestal<br>Box-Box-File<br>Locking casters<br>Depth 24" or 30"<br>work surface             | <b>PEDSWS22xxxBBFxxxxxx</b>  | 15 (381)        | 22 (559)        | 26 <sup>7</sup> / <sub>8</sub> (683) | <b>40-21-152223-27L</b> | —                   |
|   |  | <b>PEDSMLC24xxxBBFxxxxxx</b> | 15 (381)        | 24 (610)        | 26 <sup>7</sup> / <sub>8</sub> (683) | <b>40-21-152423-27L</b> | —                   |
|   |  | <b>PEDSWS28xxxBBFxxxxxx</b>  | 15 (381)        | 28 (711)        | 26 <sup>7</sup> / <sub>8</sub> (683) | <b>40-21-152823-27L</b> | —                   |
|   |  | <b>PEDSMLC30xxxBBFxxxxxx</b> | 15 (381)        | 30 (762)        | 26 <sup>7</sup> / <sub>8</sub> (683) | <b>40-21-153023-27L</b> | —                   |
|   | Mobile pedestal<br>File-File<br>Locking casters<br>Depth 24" or 30"<br>work surface                | <b>PEDSMCL22xxFFxxxxxx</b>   | 15 (381)        | 22 (559)        | 26 <sup>7</sup> / <sub>8</sub> (683) | <b>40-02-152223-27L</b> | —                   |
|   |  | <b>PEDSMCL24xxFFxxxxxx</b>   | 15 (381)        | 24 (610)        | 26 <sup>7</sup> / <sub>8</sub> (683) | <b>40-02-152423-27L</b> | —                   |
|   |  | <b>PEDSMCL28xxFFxxxxxx</b>   | 15 (381)        | 28 (711)        | 26 <sup>7</sup> / <sub>8</sub> (683) | <b>40-02-152823-27L</b> | —                   |
|   |  | <b>PEDSMCL30xxFFxxxxxx</b>   | 15 (381)        | 30 (762)        | 26 <sup>7</sup> / <sub>8</sub> (683) | <b>40-02-153023-27L</b> | —                   |
|  | Mobile pedestal<br>Box-File<br>Cushion seat<br>locking casters<br>Depth 24" or 30"<br>work surface | <b>PEDSMCLC22xBFxxxxxx</b>   | 15 (381)        | 22 (559)        | 21 <sup>1</sup> / <sub>2</sub> (546) | <b>40-11-152221-L</b>   | —                   |
|   |  | <b>PEDSMCLC24xBFxxxxxx</b>   | 15 (381)        | 24 (610)        | 21 <sup>1</sup> / <sub>2</sub> (546) | <b>40-11-152421-L</b>   | —                   |
|   |  | <b>PEDSMCLC28xBFxxxxxx</b>   | 15 (381)        | 28 (711)        | 21 <sup>1</sup> / <sub>2</sub> (546) | <b>40-11-152821-L</b>   | —                   |
|   |  | <b>PEDSMCLC30xBFxxxxxx</b>   | 15 (381)        | 30 (762)        | 21 <sup>1</sup> / <sub>2</sub> (546) | <b>40-11-153021</b>     | —                   |

**PEDESTALS**  
(ON GLIDES)

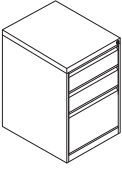
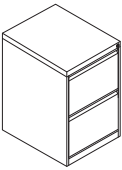
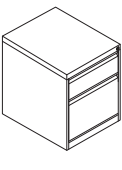
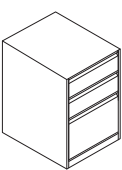
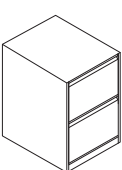
| MODEL   | DESCRIPTION   | GOVERNMENT<br>GoCUIC       | WIDTH<br>" (mm) | DEPTH<br>" (mm) | HEIGHT<br>" (mm)                     | PERFIX<br>CODE         | CEILING<br>PRICE \$ |
|---|---|----------------------------|-----------------|-----------------|--------------------------------------|------------------------|---------------------|
|    | Freestanding pedestal<br>Box-Box-File<br>Depth 24" or 30"<br>work surface               | <b>PEDSFSD22xxBBFxxxxx</b> | 15 (381)        | 22 (559)        | 26 <sup>7</sup> / <sub>8</sub> (683) | <b>41-21-152223-27</b> | -                   |
|   |   | <b>PEDSFSD24xxBBFxxxxx</b> | 15 (381)        | 24 (610)        | 26 <sup>7</sup> / <sub>8</sub> (683) | <b>41-21-152423-27</b> | -                   |
|   |   | <b>PEDSFSD28xxBBFxxxxx</b> | 15 (381)        | 28 (711)        | 26 <sup>7</sup> / <sub>8</sub> (683) | <b>41-21-152823-27</b> | -                   |
|   |   | <b>PEDSFSD30xxBBFxxxxx</b> | 15 (381)        | 30 (762)        | 26 <sup>7</sup> / <sub>8</sub> (683) | <b>41-21-153023-27</b> | -                   |
|    | Freestanding pedestal<br>File-File<br>Depth 24" or 30"<br>work surface                  | <b>PEDSFSD22xxFFxxxxxx</b> | 15 (381)        | 22 (559)        | 26 <sup>7</sup> / <sub>8</sub> (683) | <b>41-02-152223-27</b> | -                   |
|   |   | <b>PEDSFSD24xxFFxxxxxx</b> | 15 (381)        | 24 (610)        | 26 <sup>7</sup> / <sub>8</sub> (683) | <b>41-02-152423-27</b> | -                   |
|   |   | <b>PEDSFSD28xxFFxxxxxx</b> | 15 (381)        | 28 (711)        | 26 <sup>7</sup> / <sub>8</sub> (683) | <b>41-02-152823-27</b> | -                   |
|   |   | <b>PEDSFSD30xxFFxxxxxx</b> | 15 (381)        | 30 (762)        | 26 <sup>7</sup> / <sub>8</sub> (683) | <b>41-02-153023-27</b> | -                   |
|   | Freestanding pedestal<br>Box-File<br>Depth 24" or 30"<br>work surface                   | <b>PEDSFSD22xxBFxxxxxx</b> | 15 (381)        | 22 (559)        | 21 <sup>1</sup> / <sub>2</sub> (546) | <b>41-11-152221-27</b> | -                   |
|   |   | <b>PEDSFSD24xxBFxxxxxx</b> | 15 (381)        | 24 (610)        | 21 <sup>1</sup> / <sub>2</sub> (546) | <b>41-11-152421</b>    | -                   |
|   |   | <b>PEDSFSD28xxBFxxxxxx</b> | 15 (381)        | 28 (711)        | 21 <sup>1</sup> / <sub>2</sub> (546) | <b>41-11-152823-27</b> | -                   |
|   |   | <b>PEDSFSD30xxBFxxxxxx</b> | 15 (381)        | 30 (762)        | 21 <sup>1</sup> / <sub>2</sub> (546) | <b>41-11-153023-27</b> | -                   |
|  | Work surface<br>supporting pedestal<br>Box-Box-File<br>Depth 24" or 30"<br>work surface | <b>PEDSWS22xxxBBFxxxxx</b> | 15 (381)        | 22 (559)        | 27 <sup>7</sup> / <sub>8</sub> (699) | <b>41-21-152224</b>    | -                   |
|   |   | <b>PEDSWS24xxxBBFxxxxx</b> | 15 (381)        | 24 (610)        | 27 <sup>7</sup> / <sub>8</sub> (699) | <b>41-21-152424</b>    | -                   |
|   |   | <b>PEDSWS28xxxBBFxxxxx</b> | 15 (381)        | 28 (711)        | 27 <sup>7</sup> / <sub>8</sub> (699) | <b>41-21-152824</b>    | -                   |
|   |   | <b>PEDSWS30xxxBBFxxxxx</b> | 15 (381)        | 30 (762)        | 27 <sup>7</sup> / <sub>8</sub> (699) | <b>41-21-153024</b>    | -                   |
|  | Work surface<br>supporting pedestal<br>File-File<br>Depth 24" or 30"<br>work surface    | <b>PEDSWS22xxxFFxxxxx</b>  | 15 (381)        | 22 (559)        | 27 <sup>7</sup> / <sub>8</sub> (699) | <b>41-02-152224</b>    | -                   |
|   |   | <b>PEDSWS24xxxFFxxxxx</b>  | 15 (381)        | 24 (610)        | 27 <sup>7</sup> / <sub>8</sub> (699) | <b>41-02-152424</b>    | -                   |
|   |   | <b>PEDSWS28xxxFFxxxxx</b>  | 15 (381)        | 28 (711)        | 27 <sup>7</sup> / <sub>8</sub> (699) | <b>41-02-152824</b>    | -                   |
|   |   | <b>PEDSWS30xxxFFxxxxx</b>  | 15 (381)        | 30 (762)        | 27 <sup>7</sup> / <sub>8</sub> (699) | <b>41-02-153024</b>    | -                   |

*JANUARY 18, 2016*



***PERFIX*** INC.

HEAD OFFICE - SHOWROOM - PLANT :

645, Cure-Boivin blvd, Boisbriand, Qc, Canada J7G 2J2 • Tel.: 450-435-0540 • Email: sales@perfix.ca

***www.perfix.ca***

# ARMOIRES-TOUR TOWER-CABINETS

SÉRIE - 60 - SERIES



Modèle illustré :  
Model shown: 6L-02-242460

Dimension : 24" L X 24" P X 65 1/2" H  
24" W X 24" D X 65 1/2" H

Description :  
1 Casier 8" de large / 8" wide Locker  
1 Barre à cintres 8"L / 8"L Coat hanger bar  
1 Armoire / Cabinet  
2 Tablettes ajustables / Adjustable shelves  
2 Tiroirs de 12" H / 12" H drawers

AUTRE CONFIGURATION DISPONIBLE / OTHER CONFIGURATION AVAILABLE



**PERFIX.CA**

CAN/CSB  
ANSI/BIFMA



# CLASSEURS LATÉRAUX LATERAL FILES



***PERFIX*.CA**

# SÉRIE - 2000 - SERIES

## CLASSEURS LATÉRAUX

type 1 = Devant escamotable  
type 3 = Devant fixe

ENTIÈREMENT SOUDÉE  
ALL WELDED

## LATERAL FILES

type 1 = Receding front  
type 3 = Fixed front

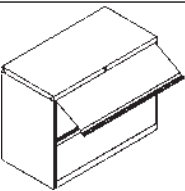
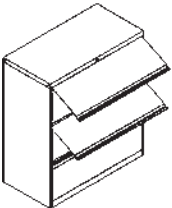
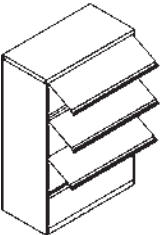
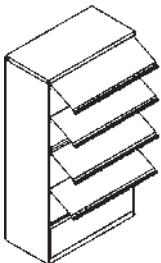
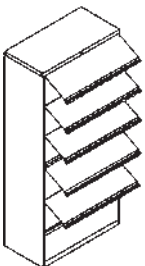
| Description   | Modèle<br>Model | Larg.<br>Width |        | Prof.<br>Depth |       | Haut.<br>Height |        |
|---|-----------------|----------------|--------|----------------|-------|-----------------|--------|
|   |                 | (")            | (mm)   | (")            | (mm)  | (")             | (mm)   |
| <br>2 Tiroirs<br>1 type 1<br>1 type 3<br><br>2 Drawers<br>1 type 1<br>1 type 3                           | 2021-13-30      | 30             | (762)  | 18             | (457) | 27 7/8          | (708)  |
|   | 2021-13-36      | 36             | (914)  | 18             | (457) | 27 7/8          | (708)  |
|   | 2021-13-42      | 42             | (1067) | 18             | (457) | 27 7/8          | (708)  |
| <br>3 Tiroirs<br>2 type 1<br>1 type 3<br><br>3 Drawers<br>2 type 1<br>1 type 3                           | 2031-113-30     | 30             | (762)  | 18             | (457) | 40 1/16         | (1018) |
|   | 2031-113-36     | 36             | (914)  | 18             | (457) | 40 1/16         | (1018) |
|   | 2031-113-42     | 42             | (1067) | 18             | (457) | 40 1/16         | (1018) |
| <br>4 Tiroirs<br>3 type 1<br>1 type 3<br><br>4 Drawers<br>3 type 1<br>1 type 3                          | 2041-1113-30    | 30             | (762)  | 18             | (457) | 53 3/8          | (1356) |
|   | 2041-1113-36    | 36             | (914)  | 18             | (457) | 53 3/8          | (1356) |
|   | 2041-1113-42    | 42             | (1067) | 18             | (457) | 53 3/8          | (1356) |
| <br>5 Tiroirs<br>4 type 1<br>1 type 3<br><br>5 Drawers<br>4 type 1<br>1 type 3                         | 2051-11113-30   | 30             | (762)  | 18             | (457) | 65 1/2          | (1664) |
|   | 2051-11113-36   | 36             | (914)  | 18             | (457) | 65 1/2          | (1664) |
|   | 2051-11113-42   | 42             | (1067) | 18             | (457) | 65 1/2          | (1664) |
| <br>6 Tiroirs<br>1 type 3<br>4 type 1<br>1 type 5<br><br>6 Drawers<br>1 type 3<br>4 type 1<br>1 type 5 | 2061-511113-30  | 30             | (762)  | 18             | (457) | 77 5/8          | (1972) |
|   | 2061-511113-36  | 36             | (914)  | 18             | (457) | 77 5/8          | (1972) |
|   | 2061-511113-42  | 42             | (1067) | 18             | (457) | 77 5/8          | (1972) |

1 SERRURE BARRANT TOUS LES TIROIRS, 2 BARRES DE SUSPENSION PAR TIROIR, SYSTÈME D'ENCLÈCHEMENT ET NIVELEURS.  
1 LOCK FOR ALL DRAWERS, 2 HANGING BARS PER DRAWER, INTERLOCKING SYSTEM AND LEVELLERS.

### OPTIONS



**PERFIX INC.**  
645, boul. du Curé-Boivin, # 100  
Boisbriand (Québec) Canada J7G 2J2  
Tél.: (450) 435-0540 - Fax: (450) 435-9983  
www.perfix.ca



Diviseur  
Divider



Contrepoids  
Counterweight

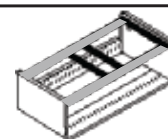

Barre de suspension  
Hanging bar

# SÉRIE - 2000 - SERIES

## CLASSEURS LATÉRAUX

type 1 = Devant escamotable  
type 3 = Devant fixe

ENTIÈREMENT SOUDÉE  
ALL WELDED

## LATERAL FILES

type 1 = Receding front  
type 3 = Fixed front

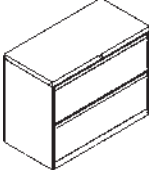
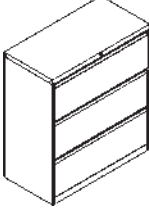
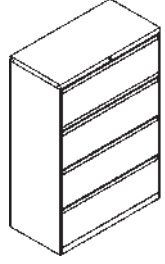
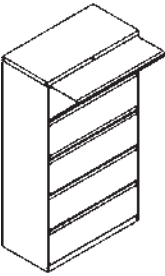
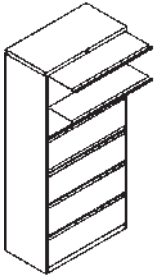
|   | Description                                   | Modèle<br>Model | Larg.<br>Width |        | Prof.<br>Depth |       | Haut.<br>Height |        |
|---|---|-----------------|----------------|--------|----------------|-------|-----------------|--------|
|   |   |                 | (")            | (mm)   | (")            | (mm)  | (")             | (mm)   |
|    | 2 Tiroirs<br>2 type 3                         | 2021-33-30      | 30             | (762)  | 18             | (457) | 27 7/8          | (708)  |
|   |   | 2021-33-36      | 36             | (914)  | 18             | (457) | 27 7/8          | (708)  |
|   | 2 Drawers<br>2 type 3                         | 2021-33-42      | 42             | (1067) | 18             | (457) | 27 7/8          | (708)  |
|    | 3 Tiroirs<br>3 type 3                         | 2031-333-30     | 30             | (762)  | 18             | (457) | 40 1/16         | (1018) |
|   |   | 2031-333-36     | 36             | (914)  | 18             | (457) | 40 1/16         | (1018) |
|   | 3 Drawers<br>3 type 3                         | 2031-333-42     | 42             | (1067) | 18             | (457) | 40 1/16         | (1018) |
|   | 4 Tiroirs<br>4 type 3                         | 2041-3333-30    | 30             | (762)  | 18             | (457) | 53 3/8          | (1356) |
|   |   | 2041-3333-36    | 36             | (914)  | 18             | (457) | 53 3/8          | (1356) |
|   | 4 Drawers<br>4 type 3                         | 2041-3333-42    | 42             | (1067) | 18             | (457) | 53 3/8          | (1356) |
|  | 5 Tiroirs<br>4 type 3<br>1 type 1             | 2051-13333-30   | 30             | (762)  | 18             | (457) | 65 1/2          | (1664) |
|   |   | 2051-13333-36   | 36             | (914)  | 18             | (457) | 65 1/2          | (1664) |
|   | 5 Drawers<br>4 type 3<br>1 type 1             | 2051-13333-42   | 42             | (1067) | 18             | (457) | 65 1/2          | (1664) |
|  | 6 Tiroirs<br>4 type 3<br>1 type 1<br>1 type 5 | 2061-513333-30  | 30             | (762)  | 18             | (457) | 77 5/8          | (1972) |
|   |   | 2061-513333-36  | 36             | (914)  | 18             | (457) | 77 5/8          | (1972) |
|   | 6 Drawers<br>4 type 3<br>1 type 1<br>1 type 5 | 2061-513333-42  | 42             | (1067) | 18             | (457) | 77 5/8          | (1972) |

1 SERRURE BARRANT TOUS LES TIROIRS, 2 BARRES DE SUSPENSION PAR TIROIR, SYSTÈME D'ENCLÈCHEMENT ET NIVELEURS.  
1 LOCK FOR ALL DRAWERS, 2 HANGING BARS PER DRAWER, INTERLOCKING SYSTEM AND LEVELLERS.



**PERFIX INC.**  
645, boul. du Curé-Boivin, # 100  
Boisbriand (Québec) Canada J7G 2J2  
Tél.: (450) 435-0540 - Fax: (450) 435-9983  
www.perfix.ca

### OPTIONS



Diviseur  
Divider



Contrepoids  
Counterweight

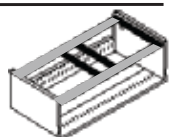

Barre de suspension  
Hanging bar



# CLASSEURS VERTICAUX VERTICAL FILES

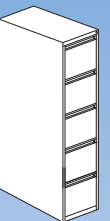
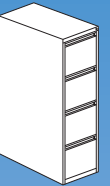
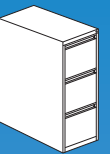
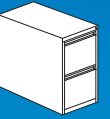

***PERFIX.CA***

# SÉRIE - 99 - SERIES

## CLASSEURS VERTICAUX

FORMAT LETTRE  
FORMAT LÉGAL

## VERTICAL FILES

LETTER SIZE  
LEGAL SIZE

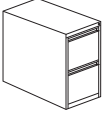
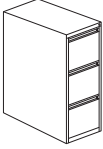
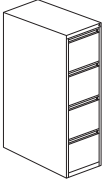
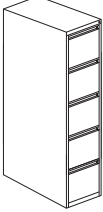
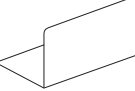
|   | DESCRIPTION  | MODÈLE<br>MODEL                | LARG.<br>WIDTH<br>("/mm) | PROF.<br>DEPTH<br>("/mm) | HAUT.<br>HEIGHT<br>("/mm)             |
|---|--|--------------------------------|--------------------------|--------------------------|---------------------------------------|
|    | Lettre / Letter<br>2 tiroirs / 2 drawers<br>Serrure / Lock | <b>99 VF 27-15</b>             | 15/381                   | 28/711                   | 27 <sup>7</sup> / <sub>8</sub> /708   |
|   | Légal / Legal<br>2 tiroirs / 2 drawers<br>Serrure / Lock   | <b>99 VF 27-18</b>             | 18/458                   | 28/711                   | 27 <sup>7</sup> / <sub>8</sub> /708   |
|    | Lettre / Letter<br>3 tiroirs / 3 drawers<br>Serrure / Lock | <b>99 VF 40-15</b>             | 15/381                   | 28/711                   | 40 <sup>1</sup> / <sub>16</sub> /1018 |
|   | Légal / Legal<br>3 tiroirs / 3 drawers<br>Serrure / Lock   | <b>99 VF 40-18</b>             | 18/458                   | 28/711                   | 40 <sup>1</sup> / <sub>16</sub> /1018 |
|  | Lettre / Letter<br>4 tiroirs / 4 drawers<br>Serrure / Lock | <b>99 VF 53-15</b>             | 15/381                   | 28/711                   | 53 <sup>3</sup> / <sub>8</sub> /1356  |
|   | Légal / Legal<br>4 tiroirs / 4 drawers<br>Serrure / Lock   | <b>99 VF 53-18</b>             | 18/458                   | 28/711                   | 53 <sup>3</sup> / <sub>8</sub> /1356  |
|  | Lettre / Letter<br>5 tiroirs / 5 drawers<br>Serrure / Lock | <b>99 VF 65-15</b>             | 15/381                   | 28/711                   | 65 <sup>1</sup> / <sub>2</sub> /1664  |
|   | Légal / Legal<br>5 tiroirs / 5 drawers<br>Serrure / Lock   | <b>99 VF 65-18</b>             | 18/458                   | 28/711                   | 65 <sup>1</sup> / <sub>2</sub> /1664  |
|  | Diviseur magnétique<br>Magnetic divider                    | <b>099-12</b><br><b>099-15</b> | 12/305<br>15/381         | 6/152<br>6/152           | 6/152<br>6/152                        |
|   | Format lettre ou légal / letter or legal size              |                                |                          |                          |                                       |



# PERFIX INC.





645, boul. du Curé-Boivin, # 100  
Boisbriand (Québec) Canada J7G 2J2  
Tél.: (450) 435-0540 - Fax: (450) 435-9983  
www.perfix.ca

**CAISSONS MOBILES**  
(SUR ROULETTES)

**SÉRIE - 40 - SERIES**

**MOBILE PEDESTALS**  
(ON CASTERS)

ENTIÈREMENT SOUDÉE  
ALL WELDED

| DESCRIPTION   | MODÈLE<br>MODEL | LARG.<br>WIDTH |       | PROF.<br>DEPTH |       | HAUT.<br>HEIGHT |       | VOLUME<br>(pi <sup>3</sup> / ft <sup>3</sup> ) | POIDS<br>WEIGHT |      |
|---|-----------------|----------------|-------|----------------|-------|-----------------|-------|--|-----------------|------|
|   |                 | (")            | (mm)  | (")            | (mm)  | (")             | (mm)  |  | (lb.)           | (kg) |
|  <p><b>2 Tiroirs 12"</b><br/><b>2-12" Drawers</b></p>   | 40-02-152224    | 15             | (381) | 22             | (559) | 27 1/2          | (699) | 5  | 110             | (50) |
|   | 40-02-152824    | 15             | (381) | 28             | (711) | 27 1/2          | (699) | 7  | 120             | (54) |
|   | 40-02-182224    | 18             | (457) | 22             | (559) | 27 1/2          | (699) | 6  | 120             | (54) |
|   | 40-02-182824    | 18             | (457) | 28             | (711) | 27 1/2          | (699) | 8  | 130             | (59) |
|  <p><b>2 Tiroirs 6"</b><br/><b>1 Tiroir 12"</b><br/><b>2-6" Drawers</b><br/><b>1-12" Drawer</b></p>           | 40-21-152224    | 15             | (381) | 22             | (559) | 27 1/2          | (699) | 5  | 120             | (54) |
|   | 40-21-152824    | 15             | (381) | 28             | (711) | 27 1/2          | (699) | 7  | 130             | (59) |
|   | 40-21-182224    | 18             | (457) | 22             | (559) | 27 1/2          | (699) | 6  | 130             | (59) |
|   | 40-21-182824    | 18             | (457) | 28             | (711) | 27 1/2          | (699) | 8  | 140             | (63) |
|  <p><b>4 Tiroirs 6"</b><br/><b>4-6" Drawers</b></p>  | 40-40-152224    | 15             | (381) | 22             | (559) | 27 1/2          | (699) | 5  | 130             | (59) |
|   | 40-40-152824    | 15             | (381) | 28             | (711) | 27 1/2          | (699) | 7  | 140             | (63) |
|   | 40-40-182224    | 18             | (457) | 22             | (559) | 27 1/2          | (699) | 6  | 140             | (63) |
|   | 40-40-182824    | 18             | (457) | 28             | (711) | 27 1/2          | (699) | 8  | 150             | (68) |
|  <p><b>1 Tiroir 3"</b><br/><b>2 Tiroirs 10 1/2"</b><br/><b>1-3" Drawer</b><br/><b>2-10 1/2" Drawers</b></p> | 40-12-152224    | 15             | (381) | 22             | (559) | 27 1/2          | (699) | 5  | 130             | (59) |
|   | 40-12-152824    | 15             | (381) | 28             | (711) | 27 1/2          | (699) | 7  | 140             | (63) |
|   | 40-12-182224    | 18             | (457) | 22             | (559) | 27 1/2          | (699) | 6  | 140             | (63) |
|   | 40-12-182824    | 18             | (457) | 28             | (711) | 27 1/2          | (699) | 8  | 150             | (68) |

1 SERRURE BARRANT TOUS LES TIROIRS. / 1 LOCK FOR ALL DRAWERS.

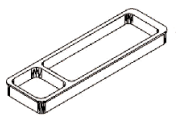

|                                      |             |  |  |  |  |  |  |  |  |  |
|--------------------------------------|-------------|--|--|--|--|--|--|--|--|--|
| <b>Plumier</b><br><b>Pencil tray</b> | 094-40-0015 |  |  |  |  |  |  |  |  |  |
|--------------------------------------|-------------|--|--|--|--|--|--|--|--|--|



|   |             |    |       |  |  |   |      |  |  |  |
|---|-------------|----|-------|--|--|---|------|--|--|--|
| <b>Diviseur 2"H</b><br><b>Divider 2"H</b> | 062-40-0015 | 15 | (381) |  |  | 2 | (51) |  |  |  |
|   | 062-40-0018 | 18 | (457) |  |  | 2 | (51) |  |  |  |

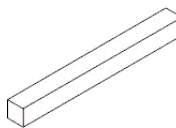

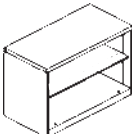
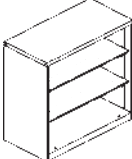
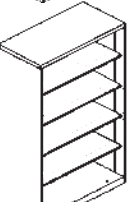
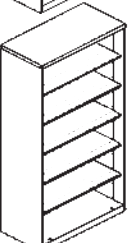

|  |        |  |  |  |  |  |  |  |  |  |
|--|--------|--|--|--|--|--|--|--|--|--|
| <b>Contrepoids</b><br><b>Counterweight</b> | 066-40 |  |  |  |  |  |  |  |  |  |
|--|--------|--|--|--|--|--|--|--|--|--|

AUTRES DIMENSIONS ET CONFIGURATIONS DISPONIBLES SUR DEMANDE.  
OTHER SIZES AND CONFIGURATIONS AVAILABLE UPON REQUEST.

| Description   | Modèle<br>Model | Larg.<br>Width<br>(") | Prof.<br>Depth<br>(") | Haut.<br>Height<br>(") |
|---|-----------------|-----------------------|-----------------------|------------------------|
|  <p>1 Tablette<br/>1 Shelf</p>     | 12-1-301824     | 30                    | 18                    | 27 7/8                 |
|   | 12-1-361824     | 36                    | 18                    | 27 7/8                 |
|   | 12-1-421824     | 42                    | 18                    | 27 7/8                 |
|  <p>2 Tablettes<br/>2 Shelves</p>  | 12-2-301836     | 30                    | 18                    | 40 1/16                |
|   | 12-2-361836     | 36                    | 18                    | 40 1/16                |
|   | 12-2-421836     | 42                    | 18                    | 40 1/16                |
|  <p>3 Tablettes<br/>3 Shelves</p>  | 12-3-301848     | 30                    | 18                    | 53 3/8                 |
|   | 12-3-361848     | 36                    | 18                    | 53 3/8                 |
|   | 12-3-421848     | 42                    | 18                    | 53 3/8                 |
|  <p>4 Tablettes<br/>4 Shelves</p>  | 12-4-301860     | 30                    | 18                    | 65 1/2                 |
|   | 12-4-361860     | 36                    | 18                    | 65 1/2                 |
|   | 12-4-421860     | 42                    | 18                    | 65 1/2                 |
|  <p>5 Tablettes<br/>5 Shelves</p> | 12-5-301872     | 30                    | 18                    | 77 5/8                 |
|   | 12-5-361872     | 36                    | 18                    | 77 5/8                 |
|   | 12-5-421872     | 42                    | 18                    | 77 5/8                 |

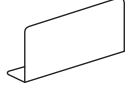

TABLETTES AJUSTABLES À TOUS LES 1 1/2" ET NIVELEURS/ADJUSTABLE SHELVES AT EACH 1 1/2" AND LEVELLERS.

|   |             |    |    |   |
|---|-------------|----|----|---|
|  <p>Tablettes<br/>Shelf</p>                       | 033-10-3018 | 30 | 18 |   |
|   | 033-10-3618 | 36 | 18 |   |
|   | 033-10-4218 | 42 | 18 |   |
|  <p>Tablette de référence<br/>Reference shelf</p> | 035-70-3018 | 30 | 18 |   |
|   | 035-70-3618 | 36 | 18 |   |
|   | 035-70-4218 | 42 | 18 |   |
|  <p>Diviseur magnétique<br/>Reference shelf</p>   | 040-18      | 2  | 18 | 6 |
|   |             |    |    |   |



**PERFIX INC.**

645, boul. du Curé-Boivin, # 100  
Boisbriand (Québec) Canada J7G 2J2

Tél.: (450) 435-0540 - Fax : (450) 435-9983

[www.perfix.ca](http://www.perfix.ca)



# **PERFIX.ca**



**9393**  
BEIGE / BEIGE



**9363**  
GRIS / GREY



**9367**  
NOIR / BLACK



**9306**



**9389**



**9345**

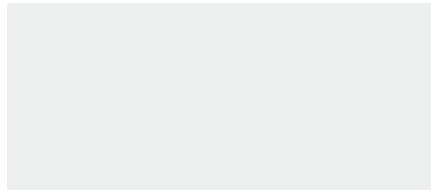

**9301**



**9364**



**9349**



**9352**

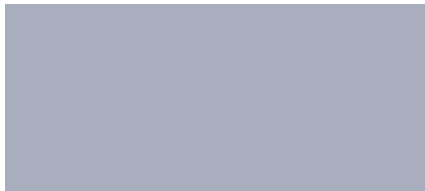

**9369**



**9355**

**- TOUTE AUTRE COULEUR DISPONIBLE, PRIX SUR DEMANDE**  
**- ANY OTHER COLOUR AVAILABLE, PRICE ON REQUEST**

Les teintes de ces échantillons peuvent différer légèrement des échantillons sur métal, le procédé d'impression sur papier ne correspondant pas à la méthode d'application sur métal. En dépit d'un contrôle sévère et continu, nos manufacturiers de peinture ne peuvent pas garantir une constance dans les couleurs, les composants chimiques et les pigments utilisés pour la fabrication des peintures pouvant entraîner des variantes de teinte incontrôlables. Toute autre couleur peut être obtenue sur présentation d'un échantillon. Une couleur spéciale entraîne automatiquement un délai de livraison plus long et peut représenter un coût additionnel. Prix sur demande.

These colour shade samples may differ slightly from metal samples, the printing process on paper being different from the application on metal. In spite of a stringent and continuous paint manufacturing control, our paint suppliers cannot guarantee 100% colour match, the chemical components and pigments used in the manufacturing process of paint entailing uncontrollable colour variation. Any other colour may be matched if a good colour sample is submitted. A special colour will automatically extend the delivery date and may increase the cost of products. Prices are available on request.



# **PERFIX.ca**

VESTIAIRES ET MOBILIER MÉTALLIQUE  
LOCKERS AND METAL FURNITURE

645, Curé-Boivin, #100, Boisbriand (Québec) J7G 2J2  
Tél.: (450) 435-0540 • Fax : (450) 435-9983  
[www.perfix.ca](http://www.perfix.ca)

FABRIQUÉ AU CANADA / MADE IN CANADA